

---

## STAIRS & PATHWAYS LUMINAIRE TYPE ( STB 01-1 )

---

IP : 40

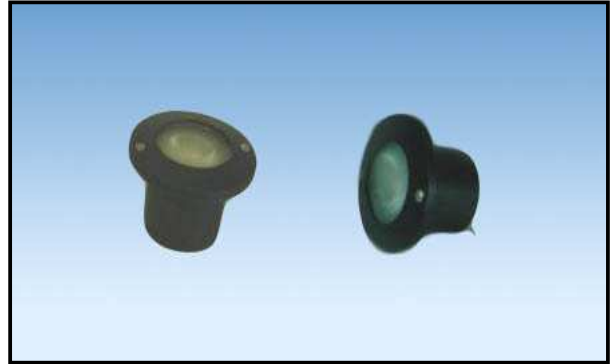
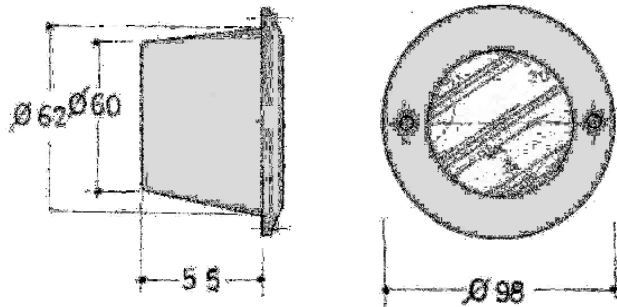

- Unit is recessed in walls “ low mounting height ” and equipped with incandescent, compact fluorescent or ball lamps.
- Die-cast aluminum circular frame “painted electrostatically”.
- Die-cast aluminum front frame contains safety glass diffuser and can be supplied with special colours on request.

---

## STAIRS & PATHWAYS LUMINAIRE TYPE ( STB 01-2 )

---

IP : 20

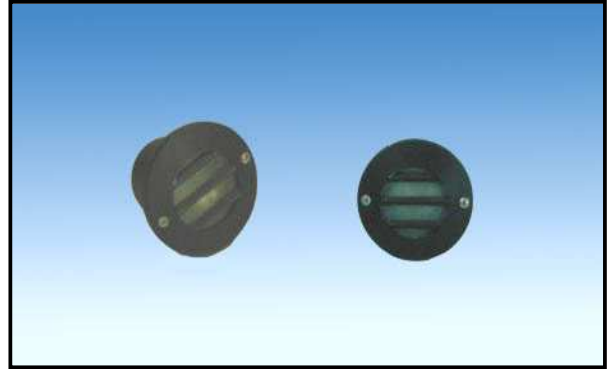
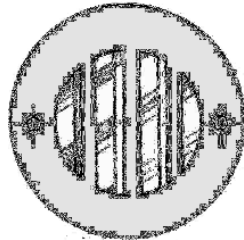
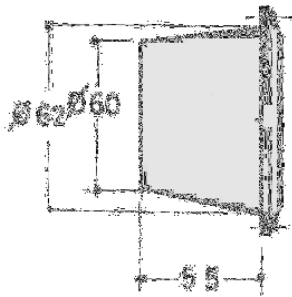

- Unit is recessed in walls “ low mounting height ” and equipped with incandescent, compact fluorescent or ball lamps.
- Die-cast aluminum circular frame “painted electrostatically”.
- Die-cast aluminum front frame contains louver structure to avoid direct lamp’s light and can be supplied with special colours on request.

---

## STAIRS & PATHWAYS LUMINAIRE TYPE ( STB 01-3 )

---

IP : 40

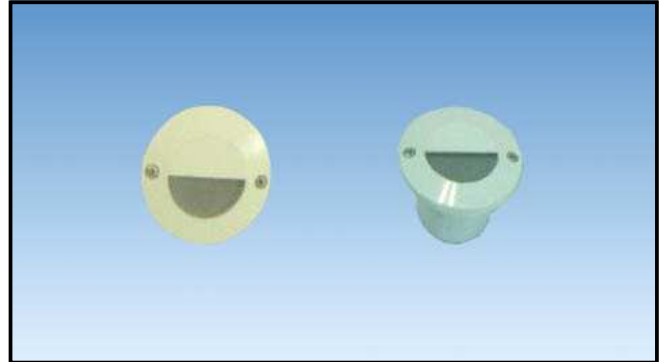
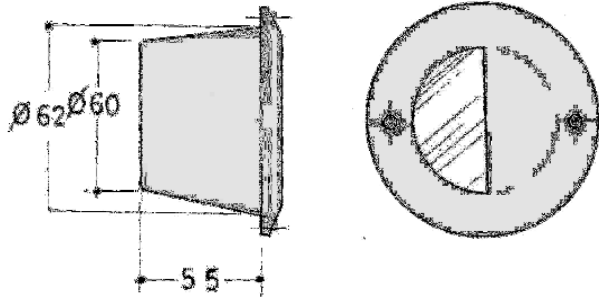

- Unit is recessed in walls “ low mounting height ” and equipped with incandescent, compact fluorescent or ball lamps.
- Die-cast aluminum circular frame “painted electrostatically”.
- Die-cast aluminum front frame has a decorative shape, contains safety glass diffuser and can be supplied with special colours on request.